

TSUBAKI PIN GEAR DRIVE UNITS

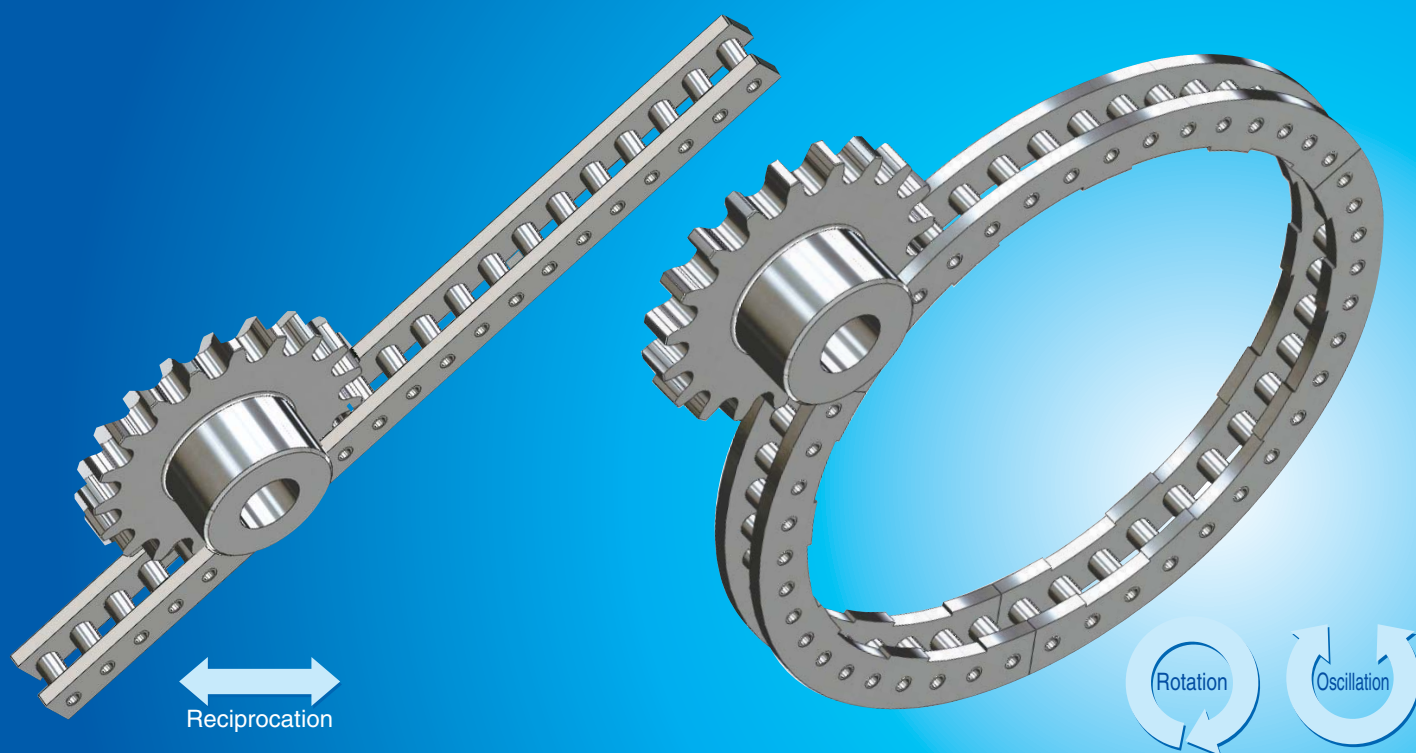

Tsubaki's Pin Gear Drive Unit replaces racks and gears.

Consisting of a pin mechanism used with a pin wheel and pin rack, and a gear with a unique tooth profile, Pin Gear Drive Units offer limitless design possibilities for linear and rotational drive sections.



Features

■ Easy installation

Employs a separable segmented design to ensure easy installation.
Allows for more flexible installation precision than rack gears.

■ Large transmission torque

The pin gear is designed with a forgiving module, and the good pin wheel/rack balance delivers large transmission torque.

■ Usable in large-scale equipment

The increased number of segments allows for use in large drive units.

■ Drive system comparison

Drive system	Installation man-hours	Transmission torque	Large equipment
Pin Gear Drive	○	○	○
Ordinary gear	△	○	△
Chain-type pin gear	△	○	○

Tsubaki provides select software on its **TT-net®** website for general technical information about power transmission equipment.

The site is designed to facilitate product selection and includes downloadable drawings and instruction manuals.



● Selection Calculations

The screenshot shows the 'Selection Calculation' tool for a pin gear drive unit. It includes sections for 'Operating conditions', 'Load calculations', 'Service factor', and 'Designated type'. A 'Display result' button is highlighted with a red box at the bottom right.

● Downloadable Instruction Manuals

The screenshot shows the 'Instruction Manuals' section of the TT-net website. A 'Catalogs/Drawings/Instruction Manuals' link is highlighted with a red box. Other links include 'Drive Chains', 'Sprockets', and 'Timing Belts'.

● Downloadable Product Drawings

The screenshot shows the 'Drawing Library' for a pin gear drive unit. It includes sections for 'Pin wheel', 'Pin gear', and 'Model no.'. A 'Show drawing' button is highlighted with a red box at the bottom.

Section	Option	Value
Pin wheel	Wheel shape	Outer rotary
	Specifications	Steel Type
	Frame no.	PDU050
Pin wheel size	Approximate pitch diameter	[mm]
	No. of converted rollers around total circumference	240
Product angle		360 [°]
Pitch diameter		3819.72 [mm]
Pin gear	Hub type	B type
	No. of teeth	18~24
Model no.	Pin wheel model no.	PDU050-GPF240P
	Pin gear model no.	PDU050-GGB024T240P

Structure

Pin Gear Drive Units include a pin gear that meshes with a pin rack or pin wheel. The pin rack or pin wheel consists of a frame, bushings, and rollers. The bushes are all hollow pin-types that can also be used as mounting holes.

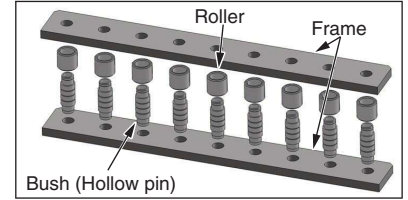

Unique Tooth Profile (Dislocated Tooth Profile)

The pin gear adopts a unique tooth profile to ensure smooth engagement with the pin rack or pin wheel and to guarantee strength. The continuous engagement of the teeth and the rollers results in flexible engagement. In addition, the steel teeth are hardened to improve strength and wear resistance.

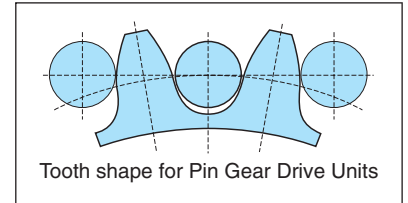

Standard Specifications

Frame No.	Pitch mm	Allowable Tangential Load kN {kgf}	
		Steel Models	Stainless Steel Models
PDU020	20	4.7 {480}	0.8 {80}
PDU022	22	7.7 {780}	1.1 {110}
PDU030	30	12.8 {1300}	1.9 {190}
PDU035	35	19.5 {1990}	2.6 {270}
PDU040	40	27.3 {2780}	4.1 {420}
PDU050	50	31.7 {3230}	5.1 {520}
PDU055	55	52.9 {5390}	7.0 {710}
PDU070	70	60.7 {6190}	9.9 {1010}
PDU080	80	71.5 {7290}	12.0 {1220}
PDU090	90	98.9 {10100}	16.8 {1710}
PDU120	120	122.5 {12490}	—
PDU150	150	240 {24500}	—
PDU180	180	347 {35400}	—
PDU240	240	525 {53400}	—

* Pin wheel pitch notation indicates circular arc pitch.

* Tangential load may be reduced for some specifications or in certain applications.

		Steel Models	Stainless Steel Models
Maximum Speed		Tangential speed: 50 m/min	
Usage Environment		Indoors (not exposed to rain or water)	Corrosive atmospheres
Usage Temperature		-10°C to 150°C	-20°C to 400°C
Materials	Frame	Rolled steel	Austenitic stainless steel
	Bush	Alloy steel	Precipitation hardened stainless steel
	Roller	Alloy steel	Austenitic stainless steel
	Pin Gear	Carbon steel (with hardened teeth)	Austenitic stainless steel

Backlash (Reference) and Center Distance Precision

Frame No.	Steel Models		Stainless Steel Models	
	Backlash (mm)	Center Distance Precision (mm)	Backlash (mm)	Center Distance Precision (mm)
PDU020	0.26 to 0.47	±0.25	0.26 to 0.47	±0.25
PDU022	0.32 to 0.57	±0.3	0.32 to 0.57	±0.3
PDU030	0.32 to 0.66	±0.4	0.32 to 0.67	±0.4
PDU035	0.33 to 0.88	±0.5	0.33 to 0.88	±0.5
PDU040	0.41 to 0.86	±0.6	0.41 to 0.86	±0.6
PDU050	0.53 to 0.98	±0.7	0.53 to 1.08	±0.7
PDU055	0.61 to 1.06	±0.75	0.61 to 1.26	±0.75
PDU070	0.86 to 1.24	±0.9	0.86 to 1.61	±0.9
PDU080	0.89 to 1.20	±1	0.89 to 1.74	±1
PDU090	0.97 to 1.42	±1.2	0.97 to 1.92	±1.2
PDU120	1.30 to 1.57	±1.6	—	—
PDU150	1.63 to 1.96	±2	—	—
PDU180	1.95 to 2.36	±2.4	—	—
PDU240	2.60 to 3.14	±3.2	—	—

* Backlash amounts are calculated figures and are not guaranteed values.

Special Backlash Specifications (Models with Varying Allowable Tangential Load)

● Large backlash specifications

Increased backlash improves the ease of installation.

● Small backlash specifications

Models with less backlash are also available. (With 2/3 the backlash of standard backlash models; Applicable frames: PDU020–PDU120)

Variations

■ Frame Numbers by Model Type and Specification

Product \ Frame No.	PDU020	PDU022	PDU030	PDU035	PDU040	PDU050	PDU055	PDU070	PDU080	PDU090	PDU120	PDU150	PDU180	PDU240
Steel Models	○	○	○	○	○	○	○	○	○	○	○	○	○	○
High Anti-Rust Specification			○	○	○	○	○	○	○	○	○			
Stainless Steel Models	○	○	○	○	○	○	○	○	○	○				
Sluice/Movable Weir Specification						○		○		○				

■ Steel Models (Standard Specification)

● Features

Steel models are the most versatile type with support for all frame numbers.

● High Anti-Rust Steel Models (Applicable Frames: PDU030–PDU120)

● Features

Stainless steel models include special surface treatment for improved corrosion resistance and weather resistance without changing the standard tangential load.

● Specifications

High anti-rust plating, high anti-rust coating, and high anti-rust painting options are available.

Frame	High anti-rust plating	Special zinc and aluminum alloy plating
Roller, Bush	High anti-rust coating	Special zinc and resin coating
Pin Gear	High anti-rust painting	Special coating with corrosion resistance and weather resistance

■ Stainless Steel Models (Standard Specification) (Applicable Frames: PDU020–PDU090)

● Features

Stainless steel models are suitable for use in corrosive atmospheres and environments with low or high temperatures.

● Specifications

All models are made of stainless steel.

Some steel models adopt different dimension. See the Table of Dimensions on page 6.

● Stainless Steel Models (Sluice/Movable Weir Specification; Linear Drive) (Applicable Frames: PDU050, PDU070, PDU090)

● Features

Sluice/movable weir specifications provide superior environmental resistance when stationary compared with standard specifications. These models also comply with technical standards (draft) for dam and weir facilities.

● Specifications

All components on the stainless steel models are made of SUS304.

* The minimum number of teeth for pin gears has been established in consideration of safety factors per the technical standards (draft) for dam and weir facilities. The minimum number of teeth is 15 for PDU050 and PDU070, and 14 for PDU090.

■ Selection Guide

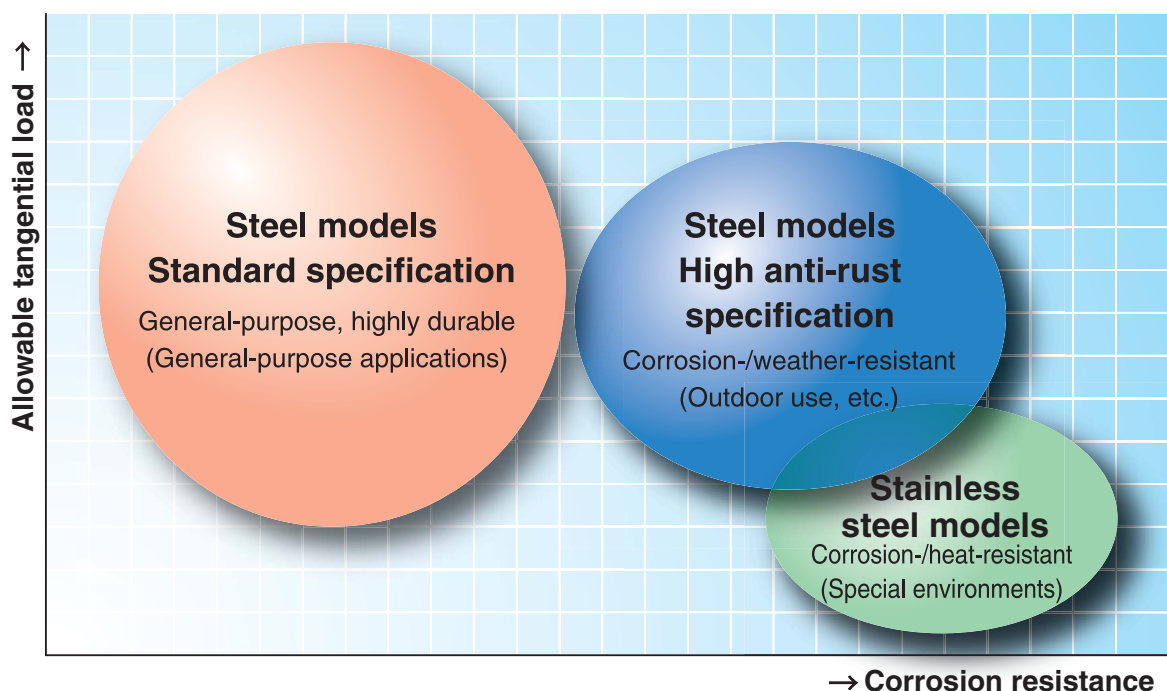

Pin Rack (Linear Drive) Products and Specifications

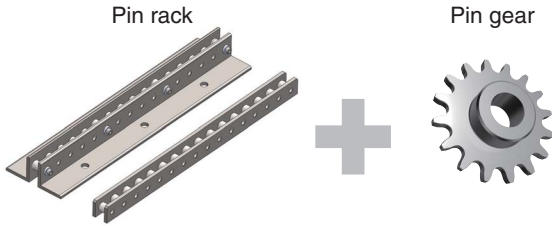

Horizontal installation (flat) pin rack: SPF

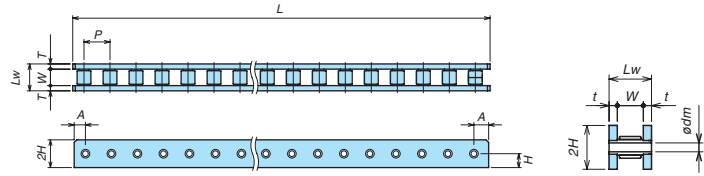

Vertical installation (angle) pin rack: SPA

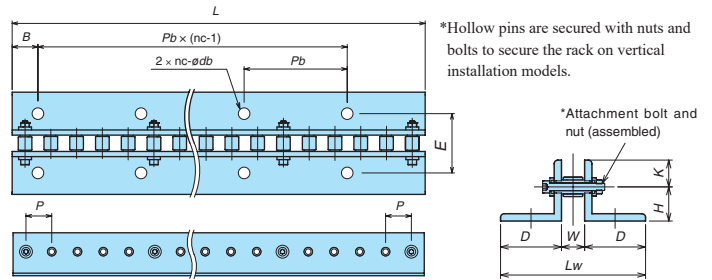

Notes:

1. The standard pin count is based on the number of pins used in segments with lengths that make them easy to handle. In addition, the minimum length and minimum number of pins are set based on manufacturing limitations.
2. If the total number of pins exceeds the standard number of pins, the standard number of pins and the number of pins less than the standard length (equal to or more than the minimum number of pins) is used for configuration.
3. See page 14 for installation instructions.
4. Mounting bolts are not included.

Linear Drive Pin Gear

Single hub model: SGB

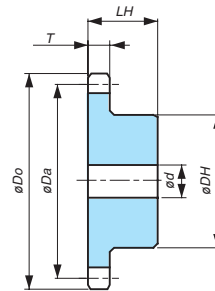

Dual hub model: SGC

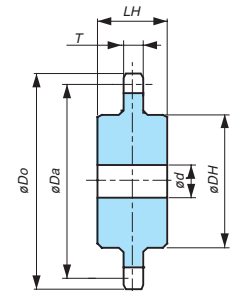

The angle shapes of vertically installed PDU180 and PDU240 differ.

Example Model No.

Pin rack

PDU050 - SPA080P - R

Frame No.

Drive system
S: Linear drive

Pin rack

Mounting type
F: Horizontal (Flat)
A: Vertical (Angle)

Overall pin count

[Blank] : Standard steel model

R : High anti-rust steel model

S : Standard stainless steel model

Pin gear

PDU050 - SGB014T - R

Frame No.

Drive system
S: Linear drive

Pin gear

No. of teeth

Pin gear model
B: Single hub model
C: Dual hub model

[Blank] : Standard steel model

R : High anti-rust steel model

S : Standard stainless steel model

Example Uses

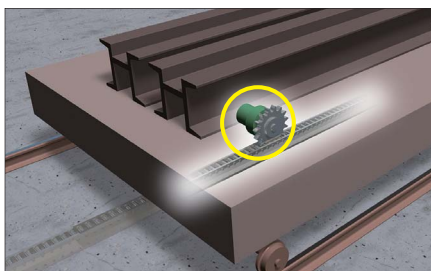

Driving large conveyor trolleys

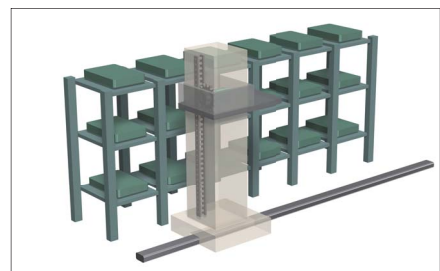

Lifting pallet pools

Pin Rack / Linear Drive Pin Gear Dimensions, Table ① (PDU020 to PDU040)

(Unit: mm)

Frame No.		PDU020	PDU022	PDU030	PDU035	PDU040		
Pitch P		20	22	30	35	40		
Roller Diameter ϕ		10.16	11.91	15.88	19.05	22.23		
Standard Length L		800	792	780	770	800		
Standard Pin Count NT		40	36	26	22	20		
Pin Gear Tooth Width T		9	12	15	18	24		
Inside Width W		12	16	19	22	28		
Pin Rack	Horizontal Installation (Flat)	Center Height H	11	12.5	16	19	22.5 (S: 25)	
		Overall Height $2H$	22	25	32	38	45 (S: 50)	
		Overall Width L_w	21 (S: 22)	25 (S: 26)	31	40 (S: 34)	46 (S: 44)	
		Plate Thickness t	4.5 (S: 5)	4.5 (S: 5)	6	9 (S: 6)	9 (S: 8)	
		Pin Position A	10	11	15	17.5	20	
		Bolt Hole Diameter ϕ_{dm}	4.5	4.5	6.5	8.8	10.8	
		Mounting Bolt Size	M4	M4	M6	M8	M10	
		Standard Weight kg	1.5 (S: 1.6)	1.8 (S: 2.0)	3.0 (S: 3.1)	5.0 (S: 3.7)	6.4 (S: 6.5)	
		Minimum Length	160	286	300	280	280	
		Minimum Pin Count	8	13	10	8	7	
	Vertical Installation (Angle)	Center Height	H	20	27	28	30	28
			K	10	13	22	20	22
		Overall Height $H+K$	30	40	50	50	50	
		Overall Width L_w	72	96	119	122	128	
		Angle Leg Width D	30	40	50	50	50	
		End Surface B	20	22	30	35	40	
		Mounting Hole Diameter ϕ_{db}	9	11	13.5	13.5	13.5	
		Mounting Bolt Size	M8	M10	M12	M12	M12	
		Mounting Hole Position E	56	60	69	76	88	
		Mounting Hole Pitch P_b	120	88	120	140	120	
Mounting Hole Count (One Side) nc	7	9	7	6	7			
Distance Between Mounting Holes $P_b \times (nc-1)$	720	704	720	700	720			
Standard Weight kg	2.4	3.3 (S: 3.4)	5.9 (S: 6.6)	7.7 (S: 6.8)	8.5 (S: 7.5)			
Minimum Length	160	132	180	210	320			
Minimum Pin Count	8	6	6	6	8			
Pin Gear	13 T	Pitch Circle Diameter ϕ_{Da}	84.76	93.44	126.94	148.43	169.92	
		Outer Diameter ϕ_{Do}	103	113	154	180	206	
		Hub	Diameter ϕ_{DH}	50	60	80	95	110
			Length LH	30	40	50	80	90
		Shaft Bore Diameter ϕ_d	Pilot Bore	12.7	15.9	19	23	28
			Max.	30	30	50	50	60
	14 T	Pitch Circle Diameter ϕ_{Da}	91.13	100.44	136.49	159.57	182.65	
		Outer Diameter ϕ_{Do}	108	119	162	189	217	
		Hub	Diameter ϕ_{DH}	50	60	80	110	120
			Length LH	30	40	50	90	100
		Shaft Bore Diameter ϕ_d	Pilot Bore	12.7	15.9	19	23	28
			Max.	30	30	50	60	70
	15 T	Pitch Circle Diameter ϕ_{Da}	97.29	107.04	145.84	170.51	194.99	
		Outer Diameter ϕ_{Do}	114	125	170	199	228	
		Hub	Diameter ϕ_{DH}	50	60	80	110	120
Length LH			30	40	50	90	100	
Shaft Bore Diameter ϕ_d		Pilot Bore	12.7	15.9	19	28	33	
		Max.	30	30	50	60	70	

* In the table above, "S" represents the dimensions/weights for stainless steel models.

Horizontal installation (flat) pin rack: SPF

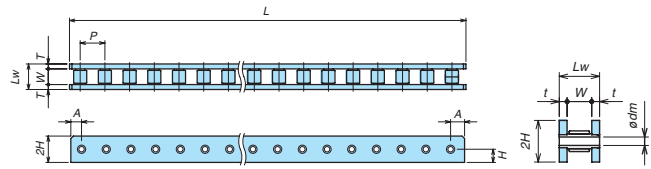

Vertical installation (angle) pin rack: SPA

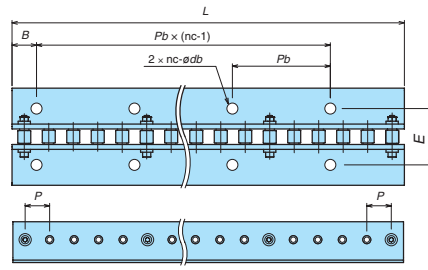

*Hollow pins are secured with nuts and bolts to secure the rack on vertical installation models.

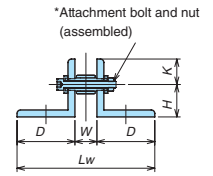

Pin Rack / Linear Drive Pin Gear Dimensions, Table ② (PDU050 to PDU090)

(Unit: mm)

Frame No.	PDU050	PDU055	PDU070	PDU080	PDU090			
Pitch <i>P</i>	50	55	70	80	90			
Roller Diameter ϕ	25.4	28.58	35.71	39.68	47.63			
Standard Length <i>L</i>	1000	990	980	960	990			
Standard Pin Count NT	20	18	14	12	11			
Pin Gear Tooth Width <i>T</i>	24	30	34	36	45			
Inside Width <i>W</i>	28	36	40	42	52			
Pin Rack	Horizontal Installation (Flat)	Center Height <i>H</i>	32.5	32.5	37.5	45	50	
		Overall Height <i>2H</i>	65	65	75	90	100	
		Overall Width <i>Lw</i>	52 (S: 46)	60 (S: 54)	72 (S: 60)	74 (S: 66)	90 (S: 76)	
		Plate Thickness <i>t</i>	12 (S: 9)	12 (S: 9)	16 (S: 10)	16 (S: 12)	19 (S: 12)	
		Pin Position <i>A</i>	25	27.5	35	40	45	
		Bolt Hole Diameter ϕ_{dm}	12.8	12.8	17	17	22	
		Mounting Bolt Size	M12	M12	M16	M16	M20	
		Standard Weight kg	14.0 (S: 11.1)	14.9 (S: 12.1)	22.2 (S: 15.6)	26.3 (S: 21.3)	36.5 (S: 26.2)	
		Minimum Length	300	495	420	560	540	
		Minimum Pin Count	6	9	6	7	6	
	Vertical Installation (Angle)	Center Height	<i>H</i> 40	37	43	55	55	
			<i>K</i> 25	28	32	35	45	
		Overall Height <i>H+K</i>	65	65	75	90	100	
		Overall Width <i>Lw</i>	158	166	190	222	252	
		Angle Leg Width <i>D</i>	65	65	75	90	100	
		End Surface <i>B</i>	50	55	70	80	90	
		Mounting Hole Diameter ϕ_{db}	17.5	17.5	17.5	22	22	
		Mounting Bolt Size	M16	M16	M16	M20	M20	
		Mounting Hole Position <i>E</i>	104	112	130	142	162	
		Mounting Hole Pitch <i>Pb</i>	150	165	210	160	180	
Mounting Hole Count (One Side) <i>nc</i>	7	6	5	6	5			
Distance Between Mounting Holes $Pb \times (nc-1)$	900	825	840	800	720			
Standard Weight kg	17.1 (S: 13.8)	18.0 (S: 14.8)	29	37	45			
Minimum Length	250	440	560	480	540			
Minimum Pin Count	5	8	8	6	6			
Pin Gear	13 T	Pitch Circle Diameter ϕ_{Da}	211.7	232.79	295.66	337.64	380.42	
		Outer Diameter ϕ_{Do}	256	282	358	409	460	
		Hub	Diameter ϕ_{DH}	130	150	180	190	220
			Length <i>LH</i>	100	140	160	160	190
		Shaft Bore Diameter ϕ_d	Pilot Bore	33	33	43	43	43
			Max.	80	90	110	110	130
	14 T	Pitch Circle Diameter ϕ_{Da}	227.62	250.3	317.94	363.11	409.07	
		Outer Diameter ϕ_{Do}	270	297	377	431	485	
		Hub	Diameter ϕ_{DH}	130	160	180	200	230
			Length <i>LH</i>	110	140	160	180	210
		Shaft Bore Diameter ϕ_d	Pilot Bore	33	33	43	43	43
			Max.	80	100	110	120	140
	15 T	Pitch Circle Diameter ϕ_{Da}	243.13	267.41	339.83	388.17	437.32	
		Outer Diameter ϕ_{Do}	284	312	397	453	510	
		Hub	Diameter ϕ_{DH}	130	160	180	200	230
			Length <i>LH</i>	110	140	160	180	210
		Shaft Bore Diameter ϕ_d	Pilot Bore	33	33	43	43	63
			Max.	80	100	110	120	140

* In the table above, "S" represents the dimensions/weights for stainless steel models.

* Stainless steel models of frame numbers PDU070 and above are for horizontal installation (flat) only.

Linear Drive Pin Gear

Single hub model: SGB

Dual hub model: SGC

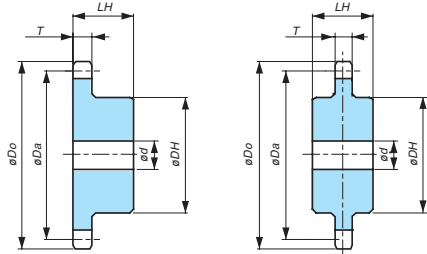

Pin Rack / Linear Drive Pin Gear Dimensions, Table ③ (PDU120 to PDU240) (Unit: mm)

Frame No.	PDU120	PDU150	PDU180	PDU240			
Pitch P	120	150	180	240			
Roller Diameter ϕ	63.5	79.38	95.25	127			
Standard Length L	960	1200	1260	1200			
Standard Pin Count NT	8	8	7	5			
Pin Gear Tooth Width T	60	75	90	120			
Inside Width W	68	94	112	150			
Pin Rack	Horizontal Installation (Flat)	Center Height H	75	75	100	125	
		Overall Height $2H$	150	150	200	250	
		Overall Width L_w	112	138	172	226	
		Plate Thickness t	22	22	30	38	
		Pin Position A	60	75	90	120	
		Bolt Hole Diameter ϕ_{dm}	32	39	45	52	
		Mounting Bolt Size	M30	M36	M42	M48	
		Standard Weight kg	60.7	88.3	161	251	
		Minimum Length	480	1200	1260	1200	
		Minimum Pin Count	4	8	7	5	
	Vertical Installation (Angle)	Center Height	H	85	85	125	157
			K	65	65	95	119
		Overall Height $H+K$	150	150	220	276	
		Overall Width L_w	368	394	462	554	
		Angle Leg Width D	150	150	175	202	
		End Surface B	120	150	Contact Tsubaki for details.		
		Mounting Hole Diameter ϕ_{db}	33	39	Contact Tsubaki for details.		
		Mounting Bolt Size	M30	M36	M42	M48	
		Mounting Hole Position E	232	270	Contact Tsubaki for details.		
		Mounting Hole Pitch P_b	240 ^{Note}	300	Contact Tsubaki for details.		
Mounting Hole Count (One Side) nc	3	4	Contact Tsubaki for details.				
Distance Between Mounting Holes $P_b \times (nc-1)$	480	900	Contact Tsubaki for details.				
Standard Weight kg	90	131	233	362			
Minimum Length	540	1200	1260	1200			
Minimum Pin Count	4	8	7	5			
Pin Gear	13 T	Pitch Circle Diameter ϕ_{Da}	508.56	635.7	762.85	1017.13	
		Outer Diameter ϕ_{Do}	615	746	925	1233	
		Hub	Diameter ϕ_{DH}	270	250	300	400
			Length LH	250	250	300	400
		Shaft Bore Diameter ϕ_d	Pilot Bore	63	68	78	78
			Max.	160	150	180	250
	14 T	Pitch Circle Diameter ϕ_{Da}	546.76	683.45	820.14	1093.52	
		Outer Diameter ϕ_{Do}	648	787	975	1300	
		Hub	Diameter ϕ_{DH}	270	270	320	430
			Length LH	250	270	320	430
		Shaft Bore Diameter ϕ_d	Pilot Bore	63	68	78	78
			Max.	160	160	200	260
	15 T	Pitch Circle Diameter ϕ_{Da}	582.96	728.7	874.44	1165.92	
		Outer Diameter ϕ_{Do}	680	827	1023	1364	
		Hub	Diameter ϕ_{DH}	280	290	340	460
Length LH			260	290	340	460	
Shaft Bore Diameter ϕ_d		Pilot Bore	63	68	78	78	
		Max.	170	180	210	280	

* Frame numbers PDU120 and above are for steel models only.

Note: The mounting hole pitch is 120 mm when the number of pins is 4 or 5.

Pin Wheel (Rotational Drive) Products and Specifications

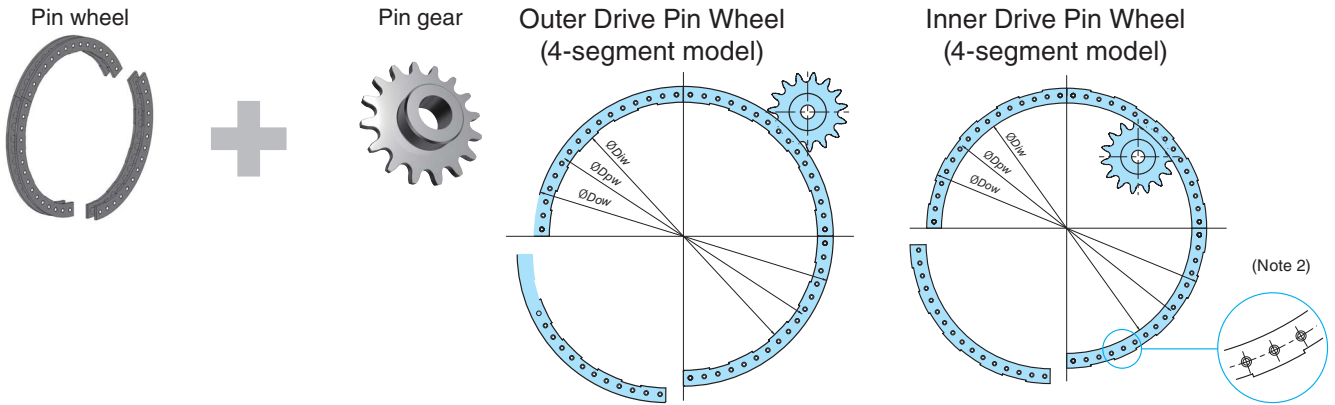

Notes:

1. Pin wheels are divided into segments.
The number of segments depends on the frame number and the overall pin count.
2. There are projections on the inner rim of outer drive pin wheel segments and on the outer rim of inner drive pin wheel segments. These projections serve as the reference surface when installing the pin wheel on the device with which it is to be used.
3. The inner diameter (D_{iw}) of outer drive wheels and the outer diameter (D_{ow}) of inner drive wheels should be used respectively as the outer/inner diameter of the device with which the pin wheel is to be used.
4. See page 14 for installation instructions.
5. Mounting bolts are not included.
6. The number of pins can be selected as desired so long as the total number of pins is 60 or more.
7. Pin wheels for partial circumferences are also available.

Example Model No.

Pin Wheel

Complete circumference

PDU070 - GPF300P - S

Frame No. Drive system Overall pin count [Blank] : Standard steel model
 G: Outer rotational drive Horizontal installation R : High anti-rust steel model
 N: Inner rotational drive Pin wheel S : Standard stainless steel model

Partial circumference (less than 360°)

PDU070 - GPF300P090P - S

Overall pin count Required number of pins [Blank] : Standard steel model
R : High anti-rust steel model
S : Standard stainless steel model

Pin Gear (Tooth shape varies depending on drive system and total number of pins on pin wheel)

PDU070 - GGC017T300P - S

Drive system Pin gear No. of teeth Total No. of pins on pin wheel [Blank] : Standard steel model
 G: Outer drive Pin gear model B: Single hub model R : High anti-rust steel model
 N: Inner drive C: Dual hub model S : Standard stainless steel model

Example uses

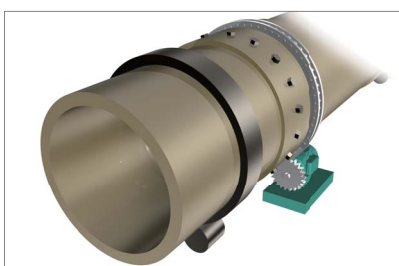

Kiln rotation

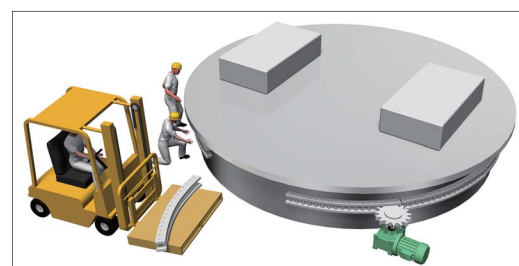

Table swiveling

Pin Wheel / Rotational Drive Pin Gear Dimensions, Table ① (PDU020 to PDU040) (Unit: mm)

Frame No.	PDU020					PDU022								
Pitch <i>P</i>	20					22								
Roller Diameter ϕ	10.16					11.91								
Pin Gear Tooth Width <i>T</i>	9					12								
Inside Width <i>W</i>	12					16								
Overall Width <i>LW</i>	21 (S: 22)					25 (S: 26)								
Plate Thickness <i>t</i>	4.5 (S: 5)					4.5 (S: 5)								
Hollow Pin Hole Diameter ϕ_{dm}	4.5					4.5								
Mounting Bolt Size	M4					M4								
Pin Wheel	Overall Pin Count	Pitch Circle Diameter ϕ_{Dpw}	Outer Diameter ϕ_{Dow}	Inner Diameter ϕ_{Diw}	Overall Pin Count	Pitch Circle Diameter ϕ_{Dpw}	Outer Diameter ϕ_{Dow}	Inner Diameter ϕ_{Diw}						
	No. of Segments	NT			NT									
	1	80	509.3	532	487	72	504.2	529	480					
	4	160	1018.59	1041	996	144	1008.41	1033	984					
	6	240	1527.89	1550	1505	216	1512.61	1537	1488					
	8	320	2037.18	2060	2015	288	2016.81	2041	1992					
12	480	3055.77	3078	3033	432	3025.22	3050	3001						
Pin Gear	No. of Teeth	Pitch Circle Diameter ϕ_{Da}	Reference Outer Diameter ϕ_{Do}	Hub Diameter ϕ_{DH}	Hub Length <i>LH</i>	Shaft Bore Diameter ϕ_d		No. of Teeth	Pitch Circle Diameter ϕ_{Da}	Reference Outer Diameter ϕ_{Do}	Hub Diameter ϕ_{DH}	Hub Length <i>LH</i>	Shaft Bore Diameter ϕ_d	
						Pilot Bore	Max.						Pilot Bore	Max.
	12	78.59	92	49	20	12.7	30	12	86.83	102	50	40	12.7	30
	13	84.76	98	50	30	12.7	30	13	93.44	108	60	40	15.9	30
	14	91.13	108	50	30	12.7	30	14	100.44	119	60	40	15.9	30
	15	97.29	113	50	30	12.7	30	15	107.04	125	60	40	15.9	30
	16	103.66	119	50	30	12.7	30	16	114.05	131	70	40	15.9	40
24	153.99	166	60	40	15.9	30	24	169.47	184	70	50	18	40	
Frame No.	PDU030					PDU035								
Pitch <i>P</i>	30					35								
Roller Diameter ϕ	15.88					19.05								
Pin Gear Tooth Width <i>T</i>	15					18								
Inside Width <i>W</i>	19					22								
Overall Width <i>LW</i>	31 (S: 31)					40 (S: 34)								
Plate Thickness <i>t</i>	6 (S: 6)					9 (S: 6)								
Hollow Pin Hole Diameter ϕ_{dm}	6.5					8.8								
Mounting Bolt Size	M6					M8								
Pin Wheel	Overall Pin Count	Pitch Circle Diameter ϕ_{Dpw}	Outer Diameter ϕ_{Dow}	Inner Diameter ϕ_{Diw}	Overall Pin Count	Pitch Circle Diameter ϕ_{Dpw}	Outer Diameter ϕ_{Dow}	Inner Diameter ϕ_{Diw}						
	No. of Segments	NT			NT									
	1	—	—	—	—	—	—	—						
	4	104	993.13	1026	961	88	980.39	1021	940					
	6	156	1489.69	1522	1457	132	1470.59	1511	1430					
	8	208	1986.25	2019	1954	176	1960.79	2001	1920					
12	312	2979.38	3012	2947	264	2941.18	2982	2901						
Pin Gear	No. of Teeth	Pitch Circle Diameter ϕ_{Da}	Reference Outer Diameter ϕ_{Do}	Hub Diameter ϕ_{DH}	Hub Length <i>LH</i>	Shaft Bore Diameter ϕ_d		No. of Teeth	Pitch Circle Diameter ϕ_{Da}	Reference Outer Diameter ϕ_{Do}	Hub Diameter ϕ_{DH}	Hub Length <i>LH</i>	Shaft Bore Diameter ϕ_d	
						Pilot Bore	Max.						Pilot Bore	Max.
	12	117.79	139	75	50	19	40	12	137.49	162	85	80	23	50
	13	126.94	147	80	50	19	50	13	148.3	171	95	80	23	50
	14	136.49	160	80	50	19	50	14	159.57	188	110	90	23	60
	15	145.84	169	80	50	19	50	15	170.51	198	110	90	28	60
	16	155.39	177	80	60	19	50	16	181.65	208	120	100	28	70
24	230.98	250	100	70	23	60	24	269.58	293	130	110	33	80	
Frame No.	PDU040													
Pitch <i>P</i>	40													
Roller Diameter ϕ	22.23													
Pin Gear Tooth Width <i>T</i>	24													
Inside Width <i>W</i>	28													
Overall Width <i>LW</i>	46 (S: 44)													
Plate Thickness <i>t</i>	9 (S: 6)													
Hollow Pin Hole Diameter ϕ_{dm}	10.8													
Mounting Bolt Size	M10													
Pin Wheel	Overall Pin Count	Pitch Circle Diameter ϕ_{Dpw}	Outer Diameter ϕ_{Dow}	Inner Diameter ϕ_{Diw}										
	No. of Segments	NT												
	1	—	—	—										
	4	80	1018.59	1067	970									
	6	120	1527.89	1576	1479									
	8	160	2037.18	2086	1989									
12	240	3055.77	3104	3007										
Pin Gear	No. of Teeth	Pitch Circle Diameter ϕ_{Da}	Reference Outer Diameter ϕ_{Do}	Hub Diameter ϕ_{DH}	Hub Length <i>LH</i>	Shaft Bore Diameter ϕ_d								
						Pilot Bore	Max.							
	12	157.79	185	100	90	28	60							
	13	169.92	197	110	90	28	60							
	14	182.65	216	120	100	28	70							
	15	194.99	226	120	100	33	70							
	16	207.72	238	120	100	33	70							
24	308.18	335	140	120	33	80								

* In the table above, "S" represents the dimensions for stainless steel models.

Pin Wheel / Rotational Drive Pin Gear Dimensions, Table ② (PDU050 to PDU090) (Unit: mm)

Frame No.	PDU050	PDU055
Pitch <i>P</i>	50	55
Roller Diameter ϕ	25.4	28.58
Pin Gear Tooth Width <i>T</i>	24	30
Inside Width <i>W</i>	28	36
Overall Width <i>LW</i>	52 (S: 46)	60 (S: 54)
Plate Thickness <i>t</i>	12 (S: 9)	12 (S: 9)
Hollow Pin Hole Diameter ϕ_{dm}	12.8	12.8
Mounting Bolt Size	M12	M12

Pin Wheel	No. of Segments	Overall Pin Count	Pitch Circle Diameter ϕ_{Dpw}	Outer Diameter ϕ_{Dow}	Inner Diameter ϕ_{Diw}	Overall Pin Count	Pitch Circle Diameter ϕ_{Dpw}	Outer Diameter ϕ_{Dow}	Inner Diameter ϕ_{Diw}
		NT				NT			
	5	100	1591.55	1647	1536	90	1575.63	1640	1511
	6	120	1909.86	1965	1854	108	1890.76	1955	1826
	9	180	2864.79	2920	2809	162	2836.14	2901	2772
	13	260	4138.03	4194	4083	234	4096.65	4161	4032
	16	320	5092.96	5148	5037	288	5042.03	5107	4978

Pin Gear	No. of Teeth NT	Pitch Circle Diameter ϕ_{Da}	Reference Outer Diameter ϕ_{Do}	Hub Diameter ϕ_{DH}	Hub Length <i>LH</i>	Shaft Bore Diameter ϕ_d		No. of Teeth NT	Pitch Circle Diameter ϕ_{Da}	Reference Outer Diameter ϕ_{Do}	Hub Diameter ϕ_{DH}	Hub Length <i>LH</i>	Shaft Bore Diameter ϕ_d	
						Pilot Bore	Max.						Pilot Bore	Max.
	12	196.59	232	110	100	33	60	12	216.08	255	135	140	33	80
	13	211.7	245	130	100	33	80	13	232.79	269	150	140	33	90
	14	227.62	268	130	110	33	80	14	250.30	295	160	140	33	100
	15	243.13	282	130	110	33	80	15	267.41	310	160	140	33	100
	16	259.05	296	140	120	33	80	16	284.91	326	170	150	33	100
	24	384.97	416	160	140	33	100	24	423.57	458	190	170	38	110

Frame No.	PDU070	PDU080
Pitch <i>P</i>	70	80
Roller Diameter ϕ	35.71	39.68
Pin Gear Tooth Width <i>T</i>	34	36
Inside Width <i>W</i>	42	42
Overall Width <i>LW</i>	72 (S: 60)	74 (S: 66)
Plate Thickness <i>t</i>	16 (S: 10)	16 (S: 12)
Hollow Pin Hole Diameter ϕ_{dm}	17	17
Mounting Bolt Size	M16	M16

Pin Wheel	No. of Segments	Overall Pin Count	Pitch Circle Diameter ϕ_{Dpw}	Outer Diameter ϕ_{Dow}	Inner Diameter ϕ_{Diw}	Overall Pin Count	Pitch Circle Diameter ϕ_{Dpw}	Outer Diameter ϕ_{Dow}	Inner Diameter ϕ_{Diw}
		NT				NT			
	5	70	1559.72	1632	1487	60	1527.89	1608	1447
	6	84	1871.66	1944	1799	72	1833.46	1914	1753
	9	126	2807.49	2880	2735	108	2750.20	2831	2670
	13	182	4055.27	4128	3983	156	3972.51	4053	3892
	16	224	4991.10	5064	4919	192	4889.24	4970	4809

Pin Gear	No. of Teeth NT	Pitch Circle Diameter ϕ_{Da}	Reference Outer Diameter ϕ_{Do}	Hub Diameter ϕ_{DH}	Hub Length <i>LH</i>	Shaft Bore Diameter ϕ_d		No. of Teeth NT	Pitch Circle Diameter ϕ_{Da}	Reference Outer Diameter ϕ_{Do}	Hub Diameter ϕ_{DH}	Hub Length <i>LH</i>	Shaft Bore Diameter ϕ_d	
						Pilot Bore	Max.						Pilot Bore	Max.
	12	273.98	321	170	160	43	100	12	312.78	365	190	160	43	110
	13	295.66	340	180	160	43	110	13	337.64	386	190	160	43	110
	14	317.94	377	180	160	43	110	14	363.11	432	200	180	43	120
	15	339.83	396	180	160	43	110	15	388.17	454	200	180	43	120
	16	362.11	416	190	160	43	110	16	413.64	477	210	200	43	130
	24	538.76	582	210	190	63	130	24	615.55	665	240	230	63	150

Frame No.	PDU090
Pitch <i>P</i>	90
Roller Diameter ϕ	47.63
Pin Gear Tooth Width <i>T</i>	45
Inside Width <i>W</i>	52
Overall Width <i>LW</i>	90 (S: 76)
Plate Thickness <i>t</i>	19 (S: 12)
Hollow Pin Hole Diameter ϕ_{dm}	22
Mounting Bolt Size	M20

Pin Wheel	No. of Segments	Overall Pin Count	Pitch Circle Diameter ϕ_{Dpw}	Outer Diameter ϕ_{Dow}	Inner Diameter ϕ_{Diw}
		NT			
	5	—	—	—	—
	6	66	1890.76	1987	1794
	9	99	2836.14	2933	2740
	13	143	4096.65	4193	4000
	16	176	5042.03	5139	4946

Pin Gear	No. of Teeth NT	Pitch Circle Diameter ϕ_{Da}	Reference Outer Diameter ϕ_{Do}	Hub Diameter ϕ_{DH}	Hub Length <i>LH</i>	Shaft Bore Diameter ϕ_d	
						Pilot Bore	Max.
	12	352.77	413	220	190	43	130
	13	380.42	438	220	190	43	130
	14	409.07	486	230	210	43	140
	15	437.32	511	230	210	63	140
	16	465.97	536	240	230	63	150
	24	692.95	751	270	260	63	160

* In the table above, "S" represents the dimensions for stainless steel models.

Outer Drive Pin Wheel
(4-segment model)

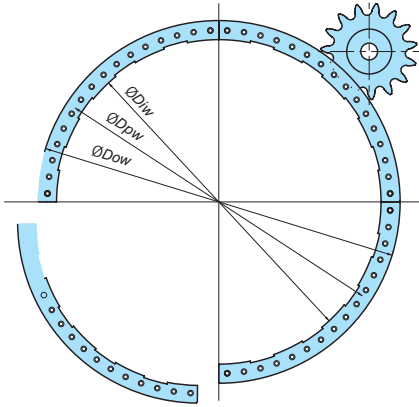

Inner Drive Pin Wheel
(4-segment model)

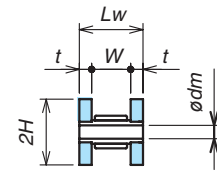
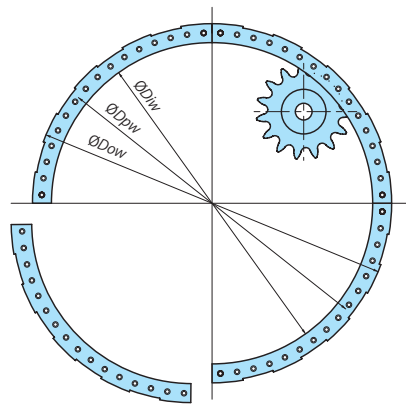

Rotational Drive Pin Gear

Single hub model: □GB

Dual hub model: □GC

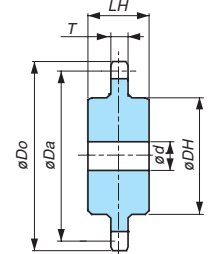
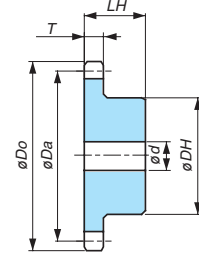

Pin Wheel / Rotational Drive Pin Gear Dimensions, Table ③ (PDU120 to PDU240) (Unit: mm)

Frame No.	PDU120					PDU150								
Pitch P	120					150								
Roller Diameter ϕ	63.5					79.38								
Pin Gear Tooth Width T	60					75								
Inside Width W	68					94								
Overall Width LW	112					138								
Plate Thickness t	22					22								
Hollow Pin Hole Diameter ϕ_{dm}	32					39								
Mounting Bolt Size	M30					M36								
Pin Wheel	Overall Pin Count	Pitch Circle Diameter ϕD_{pw}			Outer Diameter ϕD_{ow}	Inner Diameter ϕD_{iw}	Overall Pin Count	Pitch Circle Diameter ϕD_{pw}			Outer Diameter ϕD_{ow}	Inner Diameter ϕD_{iw}		
	No. of Segments	NT				NT								
	9	72	2750.20	2901	2600	72	3437.75	3588	3287					
	10	80	3055.77	3206	2905	80	3819.72	3970	3669					
	13	104	3972.51	4123	3822	104	4965.63	5116	4815					
16	128	4889.24	5040	4739	128	6111.55	6262	5961						
20	160	6111.55	6262	5961	160	7639.44	7790	7489						
Pin Gear	No. of Teeth NT	Pitch Circle Diameter ϕD_a	Reference Outer Diameter ϕD_o	Hub Diameter ϕD_H	Hub Length LH	Shaft Bore Diameter ϕd		No. of Teeth NT	Pitch Circle Diameter ϕD_a	Reference Outer Diameter ϕD_o	Hub Diameter ϕD_H	Hub Length LH	Shaft Bore Diameter ϕd	
						Pilot Bore	Max.						Pilot Bore	Max.
	12	472.37	554	260	240	63	150	12	590.46	708	230	230	68	140
	13	508.56	615	270	250	63	160	13	635.7	746	250	250	68	150
	14	546.76	629	270	250	63	160	14	683.45	787	270	270	68	160
	15	582.96	680	280	260	63	170	15	728.7	827	290	290	68	180
16	621.15	703	280	260	63	170	16	776.44	872	310	310	68	190	
24	923.73	1006	320	320	68	200	24	1154.67	1250	460	460	68	280	
Frame No.	PDU180					PDU240								
Pitch P	180					240								
Roller Diameter ϕ	95.25					127								
Pin Gear Tooth Width T	90					120								
Inside Width W	112					150								
Overall Width LW	172					226								
Plate Thickness t	30					38								
Hollow Pin Hole Diameter ϕ_{dm}	45					52								
Mounting Bolt Size	M42					M48								
Pin Wheel	Overall Pin Count	Pitch Circle Diameter ϕD_{pw}			Outer Diameter ϕD_{ow}	Inner Diameter ϕD_{iw}	Overall Pin Count	Pitch Circle Diameter ϕD_{pw}			Outer Diameter ϕD_{ow}	Inner Diameter ϕD_{iw}		
	No. of Segments	NT				NT								
	9	63	3609.63	3810	3409	—	—	—	—	—	—			
	10	70	4010.71	4211	3810	—	—	—	—	—	—			
	13	91	5213.92	5414	5013	65	4965.63	5216	4715					
16	112	6417.13	6618	6217	80	6111.55	6362	5861						
20	140	8021.41	8222	7821	100	7639.44	7890	7389						
Pin Gear	No. of Teeth NT	Pitch Circle Diameter ϕD_a	Reference Outer Diameter ϕD_o	Hub Diameter ϕD_H	Hub Length LH	Shaft Bore Diameter ϕd		No. of Teeth NT	Pitch Circle Diameter ϕD_a	Reference Outer Diameter ϕD_o	Hub Diameter ϕD_H	Hub Length LH	Shaft Bore Diameter ϕd	
						Pilot Bore	Max.						Pilot Bore	Max.
	12	708.55	850	280	280	78	170	12	944.73	1137	370	370	78	230
	13	762.85	925	300	300	78	180	13	1017.13	1233	400	400	78	250
	14	820.14	945	320	320	78	200	14	1093.52	1264	430	430	78	260
	15	874.44	1023	340	340	78	210	15	1165.92	1364	460	460	78	280
16	931.73	1047	370	370	78	230	16	1242.31	1396	490	490	78	300	
24	1385.6	1500	550	550	78	340	24	1847.46	2000	730	730	78	450	

* Frame numbers PDU120 and above are for steel models only.

Lubrication

Lubrication is a very important task for Pin Gear Drives. Before operation, coat all peripheral roller surfaces with extreme pressure grease. The interior of the pin rack and pin wheel rollers are pre-coated with lubricating grease. See the instruction manual for more information.

Reference Material for Corrosion Resistance of Stainless Steel Models

Corrosion resistance may be altered depending on the operating conditions. The table below does not indicate any guaranteed levels. See the table below and use a test sample under actual operating conditions to confirm corrosion resistance before use.

○: Sufficient corrosion resistance △: Corrosion resistance depending on operating conditions ×: No corrosion resistance —: Uncertain

Name of Chemical/Foodstuff	Rating	Name of Chemical/Foodstuff	Rating	Name of Chemical/Foodstuff	Rating
Acetone	20°C ○	Developer (photographic)	20°C △	Kerosene	20°C ○
Oil (vegetable/mineral)	20°C ○	Synthetic detergent	○	Varnish	○
Linseed oil	100%, 20°C △	Coffee	Boiling ○	Concentrated nitric acid	65%, 20°C ×
Sulfur dioxide gas (wet)	20°C ×	Cola syrup	○	Concentrated nitric acid	65%, boiling point ×
Alcohol (methyl/ethyl/propyl/butyl)	○	Acetic acid	10%, 20°C ○	Lactic acid	10%, 20°C △
Aqueous ammonia	20°C ○	Sugar solution	20°C ○	Honey, molasses	○
Whiskey	20°C ○	Calcium hypochlorite (bleaching powder) Effective chlorine 1 to 14%, 20°C	×	Paraffin	20°C ○
Ether (Ethyl ether)	20°C ○	Sodium hypochlorite	10%, 20°C ×	Beer	20°C ○
Zinc chloride	50%, 20°C ×	Sodium cyanide	20°C —	Picric acid	Saturated, 20°C ○
Ammonium chloride	50%, 20°C ×	Carbon tetrachloride (dry)	20°C ○	Fruit juice	20°C △
Potassium chloride	Saturated, 20°C △	Potassium dichromate	10%, 20°C ○	Benzene	20°C ○
Calcium chloride	Saturated, 20°C ×	Oxalic acid	10%, 20°C △	Boric acid	50%, 100°C ○
Ferric chloride	5%, 20°C ×	Tartaric acid	10%, 20°C ○	Formalin (formaldehyde) 40%,	20°C ○
Sodium chloride	5%, 20°C △	Nitric acid	5%, 20°C △	Mayonnaise	20°C △
Hydrochloric acid	2%, 20°C ×	Ammonium nitrate	Saturated boiling ○	Water	○
Chlorine gas (dry)	20°C ×	Potassium nitrate	25%, 20°C ○	Vegetable juice	20°C ○
Chlorine gas (wet)	20°C ×	Potassium nitrate	25%, boiling point ×	Lard	○
Chlorine water	×	Vinegar	20°C ×	Butyric acid	20°C ○
Oleic acid	20°C ○	Potassium hydroxide (caustic potash)	20%, 20°C ○	Hydrogen sulfide (dry)	○
Seawater	20°C ×	Calcium hydroxide (slaked lime)	Boiling ○	Hydrogen sulfide (wet)	×
Sodium perchlorate	10%, boiling point ×	Sodium hydroxide (caustic soda)	25%, 20°C ○	Sulfuric acid	5%, 20°C ×
Hydrogen peroxide	30%, 20°C △	stearic acid	100%, boiling point ×	Zinc sulfate	25%, Saturated, 20°C ○
Gasoline	20°C ○	Soft drink	20°C ○	Aluminum sulfate	Saturated, 20°C ×
Sodium permanganate	Saturated, 20°C ○	Phenol	20°C ○	Ammonium sulfate	Saturated, 20°C △
Formic acid	50%, 20°C ○	Petroleum	20°C ○	Sodium sulfate	Saturated, 20°C ○
Milk	20°C ○	Soapsuds	20°C ○	Malic acid	50%, 20°C ○
Citric acid	50%, 20°C ○	Carbonated water	20°C ○	Phosphoric acid	5%, 20°C △
Glycerin	20°C ○	Sodium bicarbonate	20°C ○	Phosphoric acid	10%, 20°C △
Creosote	20°C ○	Sodium carbonate	Saturated boiling point ○	Wine	20°C ○
Chromic acid	5%, 20°C △	Sodium thiosulfate	25%, boiling point ○		
Ketchup	20°C ○	Turpentine	35°C ○		

Installation

Installation

- Horizontal Pin Rack
- Pin Wheel

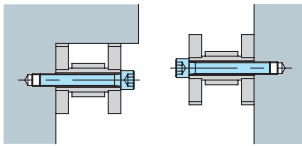

The side of the rack/wheel can be attached to the device with a bolt using the hole in the hollow pin.

When installing, a stopper or guide can be fixed to the projected surface to position the wheel.

- Vertical Pin Rack

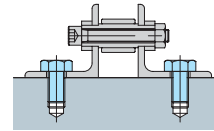

Angle racks can be attached to the device using the mounting bolt holes on the feet of the rack.

Mounting Bolt Position

At least the minimum number of bolts (see table below) must be used at both ends of each segment and at regularly spaced intervals in between.

Minimum Mounting Bolt Quantity per Segment (For Horizontal Installation)

Type	Frame No.	Mounting Bolt Size	Minimum Qty
Steel Models	PDU020	M4	8
	PDU022	M4	13
	PDU030	M6	10
	PDU035	M8	8
	PDU040	M10	7
	PDU050	M12	6
	PDU055	M12	9
	PDU070	M16	6
	PDU080	M16	7
	PDU090	M20	6
	PDU120	M30	4
	PDU150	M36	6
	PDU180	M42	6
PDU240	M48	5	
Stainless Steel Models	PDU020	M4	8
	PDU022	M4	13
	PDU030	M6	10
	PDU035	M8	8
	PDU040	M10	7
	PDU050	M12	6
	PDU055	M12	9
	PDU070	M16	6
	PDU080	M16	7
	PDU090	M20	6

Example: Bolt mounting: PDU050-GPF064P 4-segment model
Mounting position: See figure below (Mounting bolt positions indicated by black dots.)

PDU050 requires a minimum of 6, M12 mounting bolts.
Install at least 6 bolts per segment as evenly as possible.
* Contact Tsubaki if you are unsure about installation.

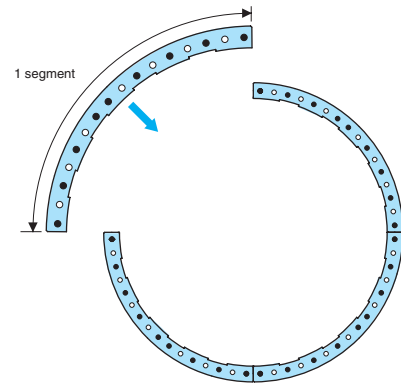

Installation Precision

- Pin racks : Ensure that the parallelism of the equipment-side reference surface of the pin rack and the pin gear center is equal to or less than the indicated gear center parallelism in the table below by ensuring that the machine is correctly aligned in advance.

Ensure that the alignment along the A and B axes of adjoining pin racks is within the tolerance indicated in the table below.

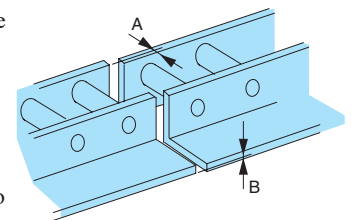

- Pin wheels : Projections on the pin wheel frame share the same centers as the roller mounting holes, so projections can be used as a reference surface for centering when fitting the pin wheel into the pilot section on the equipment.

The precision of equipment pilot section must be finished within the precision of pilot section runout indicated in the table below.

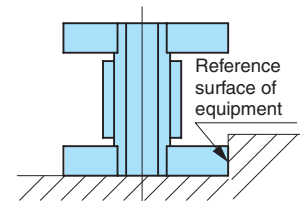
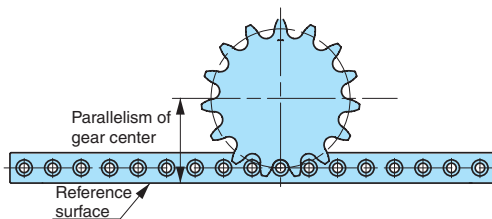

* Always read the instruction manual before installing.

	Frame No.	PDU020	PDU022	PDU030	PDU035	PDU040	PDU050	PDU055	PDU070	PDU080	PDU090	PDU120	PDU150	PDU180	PDU240
Linear drive	Parallelism of gear center (mm)	0.3	0.3	0.4	0.5	0.6	0.7	0.8	0.9	1.0	1.2	1.6	2.0	2.4	3.2
	Misalignment tolerance of A and B axes (mm)	0.1	0.2	0.2	0.3	0.3	0.4	0.4	0.5	0.5	0.6	0.8	1.0	1.2	1.5
Rotational drive	Precision of pilot section runout (mm)	0.3	0.3	0.4	0.5	0.6	0.7	0.8	0.9	1.0	1.2	1.6	2.0	2.4	3.2

Pin Gear Drive Selection Procedure

■ Selection Procedure

1. Pre-select the pitch circle diameter of the Pin Gear Drive Unit.

- For linear operation: Pre-select the pitch circle diameter of the pin gear based on the equipment layout.
- For rotational operation: Pre-select the pitch circle diameter of the pin wheel to suit the size of the equipment. Determine the reduction gear ratio required, then pre-select the pitch circle diameter of the pin gear.

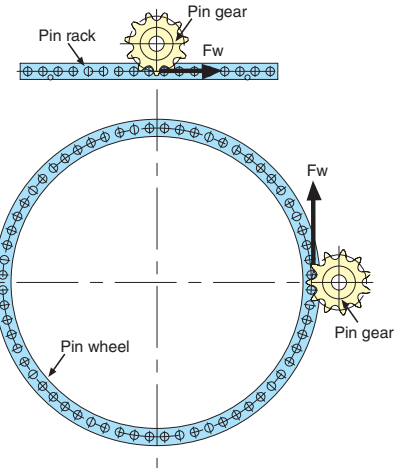

2. Calculate the applied tangential load (Fw).

Calculate the applied tangential load (Fw) that will act on the pin wheel or pin rack based on load conditions.

3. Calculate the corrected tangential load (Ft).

To calculate the corrected tangential load (Ft), obtain the service factor (Ks, Table 1) based on operating conditions, obtain the speed factor (Kv, Table 2) based on the tangential speed, and then multiply the product thereof by the applied tangential load (Fw).

$$F_t = K_s \times K_v \times F_w$$

4. Select the frame number of the Pin Gear Drive Unit.

Using the allowable tangential load (Fp) of each pin wheel/pin rack frame number and the corrected tangential load (Ft), select the appropriate Pin Gear Drive Unit that satisfies the following condition:

$$\text{Allowable tangential load (Fp)} > \text{Corrected tangential load (Ft)}$$

5. Select the model number.

- Pin wheels: From the selected frame number and the pre-selected pin wheel pitch circle diameter, choose the quantity of rollers of the pin wheel closest to the pitch circle diameter.
- Pin racks: From the selected frame number and the total running distance (or total movement distance), calculate the quantity of rack rollers.
- Pin gears: From the selected frame number and the pre-selected pin gear pitch circle diameter, choose the model number of the pin gear with the number of teeth closest to the pitch circle diameter.

Note: There are limits to the extent to which numbers of gear teeth can be used. (See table below.)
If a gear does not have enough teeth, select a gear with a larger number of teeth.

Table 1: Service Factor (Ks)

Operation Status	Operating Hours/Day		
	Up to 3 hrs	Up to 12 hrs	Up to 24 hrs
Even load	1.00 (1.25)	1.15 (1.40)	1.25 (1.50)
Load with small impacts	1.25 (1.50)	1.40 (1.70)	1.60 (2.00)
Load with large impacts	1.50 (1.80)	1.75 (2.15)	2.00 (2.50)

* Use values in parentheses if operation stops 10 or more times an hour.

Table 2: Speed Factor (Kv)

Tangential speed m/min								
0	10	15	20	25	30	35	40	50
1.02	1.04	1.05	1.06	1.06	1.07	1.08	1.1	1.2

■ Applicable Number of Teeth Range for Pin Gear

No. of Teeth NT	Linear Rack	Outer Drive Pin Wheel								Inner Drive Pin Wheel						
		60	70	80	100	150	200	250	300	60	70	80	100	150	200	250
11	×	×	×	×	×	×	×	×	×	○	○	○	○	×	×	×
12	△	×	×	×	×	×	×	×	×	○	○	○	○	○	○	○
13	○	×	×	×	×	×	△	△	△	○	○	○	○	○	○	○
14	○	×	×	△	△	△	△	△	△	○	○	○	○	○	○	○
15	○	△	△	△	△	△	△	△	△	○	○	○	○	○	○	○
16	○	△	△	△	△	△	△	△	△	○	○	○	○	○	○	○
17	○	△	△	△	△	△	△	△	○	○	○	○	○	○	○	○
18	○	△	△	△	△	△	△	○	○	○	○	○	○	○	○	○
19	○	△	△	△	△	○	○	○	○	○	○	○	○	○	○	○
20	○	△	△	△	○	○	○	○	○	○	○	○	○	○	○	○
21	○	△	△	○	○	○	○	○	○	○	○	○	○	○	○	○
22	○	△	○	○	○	○	○	○	○	○	○	○	○	○	○	○
23	○	△	○	○	○	○	○	○	○	○	○	○	○	○	○	○
24 or more	○	○	○	○	○	○	○	○	○	○	○	○	○	○	○	○

○: Applicable
△: Applicable, but tangential load may be reduced in certain applications. Consult Tsubaki for details.
×: Not applicable due to insufficient contact ratio.

Tsubaki Pin Gear Drive Unit Selection Service Sheet (For Linear Drives)

Complete this sheet to receive a report on the selection result.

Company: _____

Name: _____

Department: _____

Phone/Fax: _____

E-mail: _____

Tsubaki dealer: _____

Machinery used: (Please attach a layout diagram if possible.)

① Specifications

- Steel models
 Steel models High anti-rust specification
 Stainless steel models

② Mounting type

- Horizontal (Flat)
 Vertical (Angle)

③ Pin rack size

Overall length mm

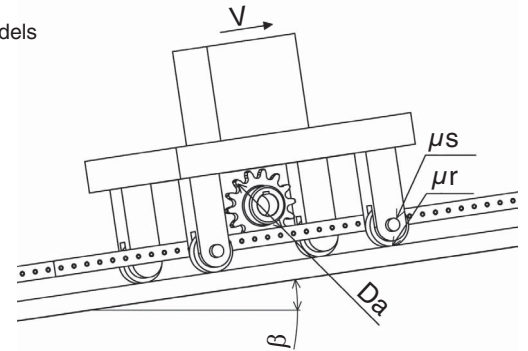

④ Movable component/conveyor component

Travel angle (β) °

Overall travel weight kg

⑤ Coefficient of frictions

Friction coefficient of wheel bearing (μ_s)

Friction coefficient when rolling wheel (μ_r)

⑥ Operating conditions

Traveling speed (V) m/min Acceleration/deceleration time sec

Operation status
 Even load
 Load with small impacts
 Load with large impacts

Daily operating time Hours

No. of start/stop operations per hour Operations

⑦ Pin gear specifications

Pitch circle diameter (Da) mm or Pin gear outer diameter mm or No. of pin gear teeth

Hub type
 B (Single hub)
 C (Dual hub)

⑧ Other specifications (Include details such as required reduction gear ratio, usage conditions, operation patterns, and other relevant points.)

Send to: TSUBAKIMOTO SPROCKET CO. FAX 0774-43-4370

Tsubaki Pin Gear Drive Unit Selection Service Sheet (For Rotational Drives)

Complete this sheet to receive a report on the selection result.

Company: _____

Name: _____

Department: _____

Phone/Fax: _____

E-mail: _____

Tsubaki dealer: _____

Machinery used: (Please attach a layout diagram if possible.)

① Specifications

- Steel models Steel models
High anti-rust specification
- Stainless steel models

② Drive system

- Outer drive Inner drive

* Table drive

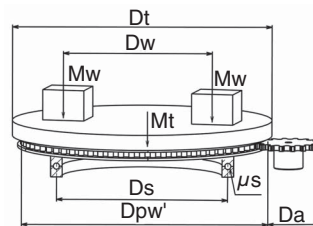

* Drum drive

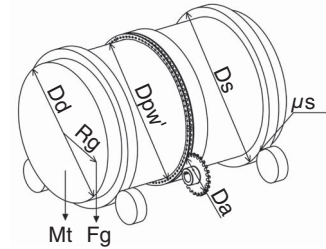

③ Pin wheel size

Mounting part diameter mm or Pitch circle diameter (Dpw') mm

④ Movable component/conveyor component

* For table drive

Outer diameter of table (Dt) mm Load rotation diameter (Dw) mm

Table weight (Mt) kg Total load (Mw) kg

* For drum drive

Drum outer diameter (Dd) mm Working radius (Rg) mm

Total weight (Mt) kg Workload (Fg) kN

⑤ Coefficient of friction

Rotational support diameter (Ds) mm Coefficient of friction of rotational support (μs)

⑥ Operating conditions

Table/drum rotation speed r/min Acceleration/deceleration time sec

Operation status Even load Load with small impacts Load with large impacts

Daily operating time Hours

No. of start/stop operations per hour Operations

⑦ Pin gear specifications

Pitch circle diameter (Da) mm or Pin gear outer diameter mm or No. of pin gear teeth

Hub type B (Single hub) C (Dual hub)

⑧ Other specifications (Include details such as required reduction gear ratio, usage conditions, operation patterns, and other relevant points.)

Send to: TSUBAKIMOTO SPROCKET CO. FAX 0774-43-4370

Safety Precautions



WARNING Observe the items below to prevent danger.

- Check that no torque is acting on the rotating shaft of the product or the equipment before installation and before performing maintenance and inspection work.
- Product function or performance may be adversely affected by mounting accuracy and load conditions or the wear and life of parts used. Implement safety measures for the equipment in advance and regularly perform maintenance and inspections.
- Follow all applicable local safety regulations as required.
- Observe the following when installing, removing, maintaining, or inspecting the product:
 - Wear suitable clothes and protective gear (e.g., safety glasses, gloves, and shoes) when working.
 - Turn off the main power switch of the equipment before conducting the work and take preventive measures so that the switch will not be turned on unexpectedly. Take the same precautions during a power failure.
 - Read and follow the instructions in the operation manuals and catalogs before conducting the work.
- When servicing or inspecting equipment that is continually subject to a load, such as lifting equipment, remove the load before starting work or take steps to prevent the equipment from falling.



CAUTION Observe the items below to prevent accidents.

- Great force will act on the mount if the product is used for applications where the product is started and stopped frequently. Make sure that the mount is sturdy enough.
- Before using the device, read the instruction manual thoroughly, and ensure the device is used correctly. If no instruction manual is available, request an instruction manual from the distributor where the device was purchased, or from the Tsubaki sales office.
- Always make sure that the operation manual is delivered to the end user.
- Product details described in this catalog are primarily intended to aid product selection. Always read the instruction manual before using any product to ensure correct use.

Warranty

1. Warranty period without charge

Tsubakimoto Sprocket Co. (hereinafter referred to as "Company") provides a warranty without charge valid for either 18 months after the shipment of the purchased product (hereinafter referred to as "Goods") from the factory, or 12 months after the first use of Goods, whichever comes first. First use of Goods is considered to be the complete incorporation of Goods into the equipment of the purchasing party (hereinafter referred to as "Customer"). This warranty may be provided with charge in certain circumstances.

2. Warranty coverage

Should any malfunction in Goods arise during the warranty period, given that Goods were properly installed, operated, and maintained as instructed in the catalog, instruction manual, or similar, Company shall promptly deliver or repair Goods or the failed part at no charge once Company has confirmed such failure. This warranty only covers delivered Goods and therefore does not include the following: ("Instruction manual or similar" includes documentation specially provided to Customer.)

- (1) Any costs required for the removal or mounting of Goods from or into Customer's equipment for repair or replacement.
- (2) Costs required for transporting Customer's equipment to repair shop, etc.
- (3) Profits lost due to a malfunction or repair, or any other consequential loss.

3. Warranty with charge

Company will charge for any investigation and repair of a malfunction in Goods (even during the warranty period) if caused by:

- (1) Improper location, installation, lubrication, or maintenance by Customer's failing to follow the catalog, instruction manual, or similar. ("Instruction manual or similar" includes documentation specially provided to Customer.)
- (2) Operation methods (including usage conditions, usage environment, and allowable values) resulting from Customer's failure to follow operation described in the catalog, instruction manual, or similar. ("Instruction manual or similar" includes documentation specially provided to Customer.)
- (3) Inappropriate disassembly, modification, alteration, or processing by Customer.
- (4) Use of Goods by Customer in conjunction with damaged or worn parts not made by Company.
- (5) Failure of operational life under conditions of use as determined by Company to satisfy operational life covered by Warranty.
- (6) Use by Customer under conditions other than those discussed.
- (7) Consumption, wear, or deterioration of bearings, oil seals, oil, and other consumable parts incorporated into Goods.
- (8) Secondary failure or malfunction resulting from malfunctioning of Customer's equipment.
- (9) Malfunction of Goods resulting from a Force Majeure such as an act of God.
- (10) Malfunction of Goods resulting from a wrongful act committed by a third party.
- (11) Any other reason that is not attributable to Company.

The logos, brand names, or product names in this catalog are trademarks or registered trademarks of Tsubakimoto Chain Co. and/or its subsidiaries and/or affiliates in Japan, the U.S. and/or other countries.



TSUBAKIMOTO CHAIN CO.

Headquarters

Nakanoshima Mitsui Building
3-3-3 Nakanoshima, Kita-ku
Osaka 530-0005, Japan
Phone : +81-6-6441-0011
Facsimile : +81-6-6441-0489
Internet:
<https://tsubakimoto.com/>

Global Associated Partners:

NORTH and SOUTH AMERICA

**U.S. TSUBAKI
POWER TRANSMISSION, LLC**
301 E. Marquardt Drive
Wheeling, IL 60090-6497
U.S.A.
Phone : +1-847-459-9500
Facsimile : +1-847-459-9515

TSUBAKI of CANADA LIMITED
1630 Drew Road
Mississauga, Ontario, L5S 1J6
Canada
Phone : +1-905-676-0400
Facsimile : +1-905-676-0904

**Tsubaki Brasil Equipamentos
Industriais Ltda.**
Rua Dom Bernardo Nogueira, 55,
CEP 04134-000 - São Paulo, SP
Brazil
Phone : +55-11-3253-5656

EUROPE

TSUBAKIMOTO EUROPE B.V.
Aventurijn 1200, 3316 LB Dordrecht
The Netherlands
Phone : +31-786-204000
Facsimile : +31-786-204001

TSUBAKIMOTO U.K. LTD.
Osier Drive, Sherwood Park
Annesley, Nottingham
NG15 0DX U.K.
Phone : +44-1623-688700
Facsimile : +44-1623-688789

TSUBAKI DEUTSCHLAND GmbH
Münchner Straße 135, D-85774,
Unterföhring, Germany
Phone : +49-89-2000-133-80
Facsimile : +49-89-2488768-66

Tsubaki Ibérica Power Transmission S.L.
Calle de Juan de la Cierva 28, 28823
Coslada, Madrid
Spain
Phone : +34-911-873450

ASIA and OCEANIA

TSUBAKIMOTO SINGAPORE PTE. LTD.
25 Gul Lane
Jurong
Singapore 629419
Phone : +65-6861-0422/3/4
Facsimile : +65-6861-7035

TSUBAKIMOTO VIETNAM CO., LTD.
Unit 202, 2nd Floor, DMC Tower,
No.535 Kim Ma, Ngoc Khanh Ward,
Ba Dinh District, Hanoi
Vietnam
Phone : +84-24-6274-1449

PT. TSUBAKI INDONESIA TRADING
Graha Bulevar Blok GB/B17, Jl Bulevar
Ahmad Yani, Kelurahan Harapan Mulya
Kecamatan Medan Satria, Kota Bekasi,
Jawa Barat 17143, Indonesia
Phone : +62-21-8945-8898
Facsimile : +62-21- 8945-8899

**TSUBAKI POWER TRANSMISSION (MALAYSIA)
SDN. BHD.**
No. 8, Jalan Utarid U5/16, Mah Sing
Integrated Industrial Park, Section U5,
40150 Shah Alam, Selangor
Malaysia
Phone : +60-3-5888-8275
Facsimile : +60-3-2178-4353

TSUBAKIMOTO CHAIN (SHANGHAI) CO., LTD.
Building A, Rm. 306-308, Shanghai
MixC City, 1799 WuZhong Road,
Minhang District, Shanghai, 201103
People's Republic of China
Phone : +86-21-5396-6651/2
Facsimile : +86-21-5396-6628

TSUBAKIMOTO KOREA CO., LTD.
#1407~1410 East Wing, Hanshin
Intervalley 24. 322, Teheran-ro
Gangnam-gu, Seoul 1004, Korea
Phone : +82-2- 2183-0311
Facsimile : +82- 2- 2183-0314

TAIWAN TSUBAKIMOTO CO.
No. 33, Lane 17, Zihciang N. Road,
Kueishan District, Taoyuan City 33347
Taiwan R.O.C
Phone : +886-3-3293827
Facsimile : +886-3-3293065

Tsubakimoto Philippines Corporation
Room 415, Peninsula Court, 8735
Paseo De Roxas cor Makati Ave., 1226
Makati City, Manila
Philippines
Phone : +63-2-8824-7519

TSUBAKIMOTO (THAILAND) CO., LTD.
388 Exchange Tower, 19th Floor Unit
1902, Sukhumvit Road, Klongtoey
Bangkok 10110 Thailand
Phone : +66-2-262-0667/8/9 (3 lines)
Facsimile : +66-2-262-0670

**TSUBAKI INDIA POWER TRANSMISSION
PRIVATE LIMITED**
Shri Kailash Logicity, No.165,
Venbakkam Village, Panruti Post,
Oragadam - Walajabad Road
Kancheepuram District, Tamil
Nadu 631604, India
Phone : +91-44-7101-2000
Facsimile : +91-44-7101-2001

TSUBAKI AUSTRALIA PTY. LTD.
Unit E, 95-101 Silverwater Road
Silverwater, N.S.W. 2128
Australia
Phone : +61-2-9704-2500
Facsimile : +61-2-9704-2550

**TSUBAKI AUSTRALIA PTY LIMITED
NEW ZEALAND BRANCH**
PwC Tower, Level 26
188 Quay Street
Auckland 1010
New Zealand
Phone : +64-9-352-2085

Distributed by: